



Footrot

A guide to identification
and control in the field



www.sheepconnectnsw.com.au



Australian Wool
Innovation Limited



Primary
Industries

Contents

1. Overview	4	7. Eradication inspections.....	40
2. Identifying footrot in the field	8	8. Treatment	44
3. Footrot diagnosis	18	9. Footbath design and construction....	52
4. Taking a sample	22	10. Surveillance and prevention.....	62
5. Eradication	30	Glossary	66
6. Footrot vaccine	38		

Published by Australian Wool Innovation Ltd.
February 2022

This publication should only be used as a general aid and is not a substitute for specific advice. To the extent permitted by law, we exclude all liability for loss or damage arising from the use of the information in this publication.

© 2022 Australian Wool Innovation Ltd. All rights reserved.

Australian Wool Innovation Ltd gratefully acknowledges the funds provided by the Australian government to support research, development and marketing of Australian wool and the contributions made through the NSW Sheep Advisory Group to this guide.

For further information:

Contact your Local Land Services Biosecurity Officer or District Veterinarian, veterinarian or livestock consultant

<https://www.lls.nsw.gov.au/help-and-advice/livestock-health-and-production>

LLS: 1300 795 299 DPI Biosecurity: 1800 680 244



Primary
Industries



Introduction

Footrot is a contagious disease of sheep caused by the bacterium *Dichelobacter nodosus*. As a disease of the foot it commonly presents as lameness, and is generally introduced into a flock via infected sheep (introduced, returning or straying animals). Footrot (especially the virulent strains) can be a severe, debilitating disease.

Importantly, in NSW footrot is a notifiable disease and any lame sheep must be reported within one working day to a Local Land Services (LLS) or NSW DPI authorised officer for investigation.

Footrot has significant welfare and economic impacts in both individual sheep enterprises and the national flock as a whole.

This publication has been developed as part of a collaborative project between Australian Wool Innovation (AWI), AWI Sheep Connect NSW and NSW Sheep Advisory Group.

The purpose of this publication is to encourage best-practice footrot diagnosis, control and eradication, with the objective of building a more sustainable Australian wool industry through improvements in productivity and profitability.

Better diagnosis and control of footrot should result in:

- healthier, more productive sheep
- easier trading between flocks
- lower treatment and labour costs
- increased confidence in state-based control programs.

About Sheep Connect NSW

Sheep Connect NSW (SCNSW) is Australian Wool Innovation's key extension network in NSW. SCNSW connects with producers in the sheep industry to assist industry with improving productivity in all facets of sheep and wool production.

Key objectives of SCNSW are to:

- provide the sheep and wool industry with information to improve productivity in their business.
- deliver timely and relevant information to sheep producers in response to industry requirements.
- actively support the delivery of skills and knowledge to the NSW sheep industry.
- enhance and share industry intelligence by facilitating two-way communication and cooperation between sheep producers and industry service providers.

Overview

Key messages

- Footrot is a serious and highly-contagious disease of sheep and goats caused by the *Dichelobacter nodosus* bacterium.
- Under suitable environmental conditions (moist and warm) *D. nodosus* bacteria can penetrate and infect the skin between the toes leading to pain and lameness.
- Discharge from the feet of infected animals spreads to the feet of previously unaffected animals via moist pasture, stubble, yards and laneways.
- Footrot has significant impacts on enterprise productivity and profitability, as well as animal and human welfare.
- The key to management is early detection and treatment.

NOTE: See **Section 2. Identifying footrot in the field** for further details on how to diagnose footrot and differentiate it from other conditions causing lameness in sheep.

What is footrot?

Footrot is a serious and highly contagious bacterial disease which affects the feet of sheep and goats.

The first sign of infection is reddening of the skin between the toes. This can rapidly develop and spread to cause under-running and separation of the hard horn of the hoof from the sensitive soft tissue underneath, resulting in pain and lameness. Under ideal conditions, the disease can progress from reddened skin to severe under-running in 10–14 days.

Footrot is an important condition due to its economic impacts on farming enterprises and animal and human welfare implications.

How is footrot spread?

Footrot is caused by the bacterium *Dichelobacter nodosus*. The *D. nodosus* bacteria thrives in moist mild conditions. Although footrot can occur throughout Australia, it is most common in medium to high rainfall areas.

There are many strains of *D. nodosus*, which vary in their ability to cause disease. The severity of footrot occurs on a spectrum from benign to virulent, and the severity of disease seen in affected sheep or on an affected property is influenced by a combination of three factors:

- disease agent (strain or strains of bacteria present in the foot);
- environmental conditions (rainfall and temperature); and
- host (sheep breed and genetics).

As such, there is a possibility that benign lesions or chronic lesions in carriers may contain virulent strains of the bacterium, but not currently be causing virulent disease. Benign types (also known as 'scald') usually only affect the skin between the toes regardless of the environmental conditions. Virulent types often cause severe under-running (except in goats) and spread rapidly in warm, moist conditions.

Disease outbreaks usually occur when the average daily temperature is above 10 degrees Celsius, so spread does not usually occur during very cold winters, but mostly during mild, wet winters, autumn and spring. The spread of footrot is drastically reduced under hot dry conditions — greater than 25mm of rain per month is generally required for footrot to spread during summer.

While the bacterium cannot usually survive for longer than seven days in soil and dies quickly in dry conditions, it can survive for years in the feet of infected animals, even when environmental conditions are hostile.

The ability of the soil type to retain moisture and the pasture type both play a role in disease spread and expression.

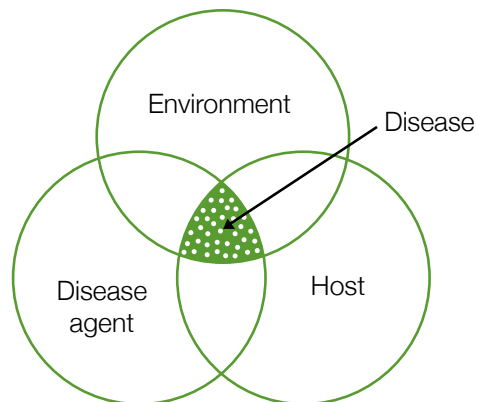

Factors affecting disease expression:

Expression in the flock is affected by three factors: environment, disease agent and host. Footrot is only observed in its most obvious form when all three factors are favourable and aligned.

Prolonged wet conditions underfoot often cause damage to the skin between the toes (interdigital skin), allowing bacteria to establish in the damaged tissue. Post-harvest crop stubble and long pasture species also can damage the interdigital skin, favouring footrot infection.

Discharge from the feet of infected animals is the main source of infection by contaminating pastures and yards. Bacteria in the discharge spreads from the feet of infected animals to those of previously unaffected animals via moist, contaminated pasture, yards and laneways.

Goats, deer and cattle also can carry and spread the bacteria, although surveys of fallow deer have failed to detect footrot, and cattle almost always only carry benign footrot.

Goats are susceptible to footrot in the same way as sheep, and disease spread, symptoms, impacts and treatment are similar.

Animal susceptibility

Some sheep breeds are more susceptible to footrot than others and even within one breed of sheep some individuals are more resistant than others. Merinos generally tend to be more susceptible to footrot than British breeds of sheep, such as Dorset and Border Leicester.

Footrot can occur in sheep of all ages. Generally the severity of lesions in ewes increases with age and older lambs have more severe lesions than younger ones.

Prior natural infection does not provide immunity to subsequent challenges.

A large proportion of a mob can be affected within one to two weeks of exposure to the bacteria. Spread within a mob is assisted by the natural flocking instinct of sheep, particularly when there is heavy contamination around common feeding and drinking areas.

Both claws of a foot and often more than one foot on the sheep will be affected.

Sheep with apparently healthy looking feet may still carry a virulent strain of footrot if conditions at the time are not favourable for the bacteria's development. Infection may only become apparent when environmental conditions become warm and moist or careful diagnostic paring is carried out.

Economic and welfare impacts

Footrot can have a major impact on flock productivity and profitability. Lameness and pain in affected animals reduces their mobility and ability to graze efficiently. This results in poorer growth rates, longer finishing times, higher mortality rates, reduced wool production and quality (fibre diameter and tensile strength are affected) and lower ewe fertility.

Foot note

Lambing percentages and fleece weights are estimated to be reduced by 10% in sheep with at least one severely affected foot. The greater the severity of footrot in a flock, the greater the impact on productivity and profitability.

Footrot can be a major animal welfare issue for sheep. Infection and erosion of the sensitive tissue in the feet can cause extreme pain, and in severe cases the hard horn of the hoof may slough off.

Often, animals cannot bear weight on affected feet and if more than one foot is affected they may be unable to stand. Affected sheep limp, carry the affected leg and may graze on their knees. Animals unable to walk and graze for long enough become emaciated and can starve to death.

Associated impacts

The discharge associated with footrot attracts flies, so many footrot-affected sheep suffer flystrike of infected feet, resulting in additional pain. When the front feet are affected this can lead to body strike if the sheep lies down with the infected front foot resting against its side.

Footrot-affected ewes are also more predisposed to developing pregnancy toxemia during late pregnancy, which may lead to the death of both the ewe and her progeny.

In addition to direct losses of production and profit, additional economic impacts occur through the need for repeat yardings of sheep and disruption to farm routine, together with the expense of labour and materials to treat the disease.

Market access is also affected: infected sheep cannot be sold through a saleyard — they may be sold direct to slaughter only, and some overseas markets will only buy sheep from flocks certified as 'footrot free'.

Foot note

Footrot is a serious disease of sheep. For more information on preventing, diagnosing and treating footrot contact your local veterinarian or animal health advisor.

New South Wales, South Australia and Western Australia have state footrot control programs. In these states, when footrot is suspected an inspector of livestock must be notified and may need to restrict the movement of infected or suspect sheep, and assist in implementing a treatment plan.

Footrot also has impacts on human welfare. Footrot can be difficult to control or eradicate when established in a flock. It can be time consuming and frustrating to manage. Many farmers find the psychological, economic and welfare impacts of the disease in their flock extremely distressing.

Footrot can also sometimes affect a whole community by creating unnecessary ill-feeling and hostility between neighbours and friends as individuals are blamed for the introduction and spread of disease in a community.

Identifying footrot in the field

Key messages

- Lameness is the first sign of footrot. Inspect sheep with signs of lameness promptly.
- Footrot can be difficult to diagnose and differentiate from other common foot and lower-leg diseases and conditions in sheep and goats.
- A scoring system has been developed to describe the signs and progression of footrot. Score 0 is a healthy foot, Score 1 is the mildest stage of the disease through to Score 5, which is the most advanced stage.
- There are many strains (or types) of footrot bacteria (*Dichelobacter nodosus*) which vary in their ability to cause disease from benign to extremely virulent.
- Laboratory tests can confirm the presence of footrot and may assist in determining the virulence status of any footrot infection.

Identifying footrot

Lameness is the first sign of footrot and any signs of lameness should be investigated promptly. Footrot can be difficult to distinguish from other diseases and conditions of the foot and lower leg of sheep and goats.

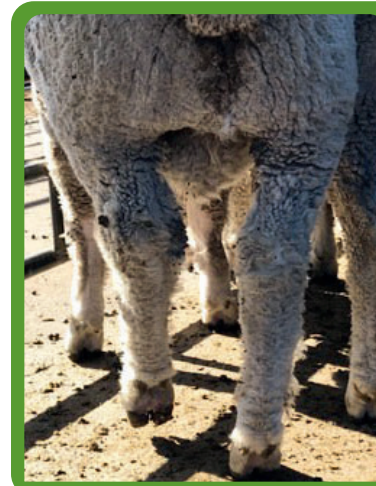

First signs:
Lameness is often the first sign of footrot. Inspect any lame sheep for footrot as soon as possible in order to implement a timely eradication program.

A prompt, accurate diagnosis will help to determine the best treatment program and reduce the impacts of the disease.

An initial footrot diagnosis is made by examining the foot for the presence of a lesion that is characteristic of footrot, as shown on the following pages.

Infected feet often, but not always, have a characteristic foul smell.

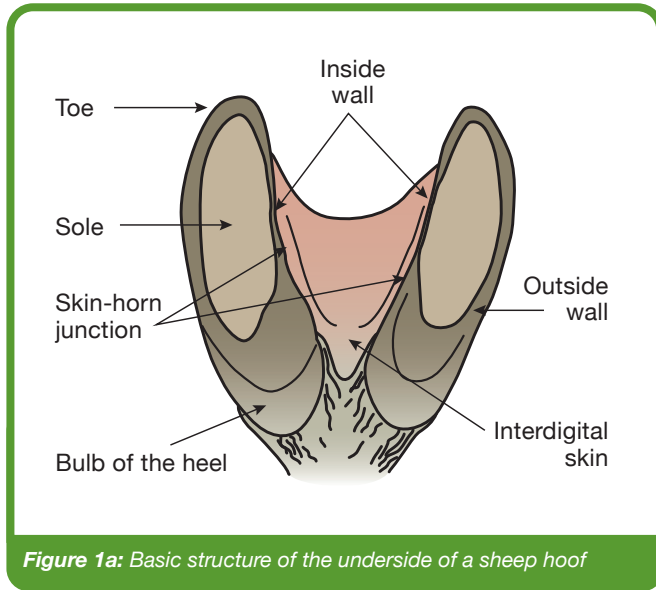

The signs of footrot infection vary from mild reddening of the interdigital skin (between the toes) to complete separation of the hard horn of the hoof from the soft tissue underneath. Figures 1a and 1b below show the basic structure of the hoof as a reference for the descriptions of each successive stage of infection covered on the following pages.

Benign footrot usually only involves the interdigital skin, inside wall and skin-horn junction, but this can also be the first stage of virulent footrot.

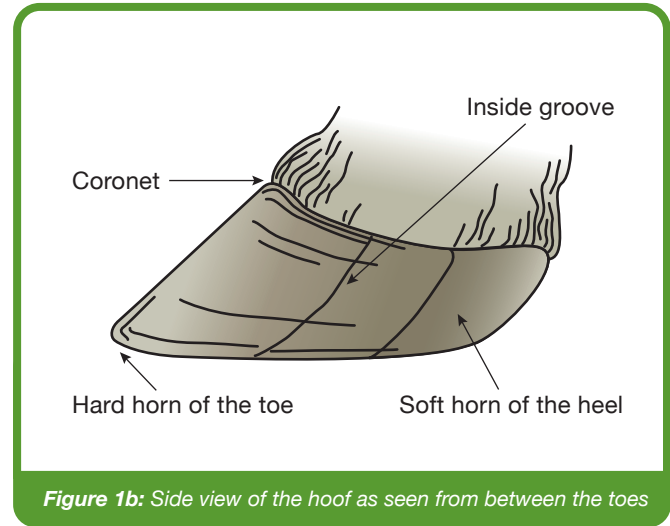

Foot scoring

A scoring system has been developed to describe the signs and progression of footrot. Score 1 is the mildest stage of the disease through to Score 5, which is the most advanced stage.

The five stages/scores are outlined on the following pages.

Normal foot



There is normal skin between the claws, with no reddening or inflammation and no loss of hair. There is no exudate present.

NSW DPI

Score 1



Slight to moderate inflammation with some erosion between the claws. There is no under-running or erosion of the skin or horn.

NSW DPI

Score 2



The skin between the claws is inflamed and raw. This condition may involve part, or all, of the soft horn on the inside of the claws. There is no under-running of the horn.

NSW DPI

Score 3



A.



B.

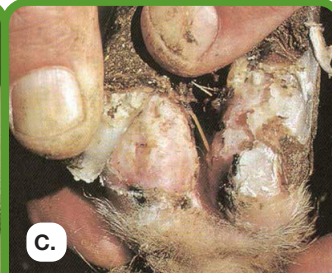

C.

A. Separation of the skin horn junction, with under-running extending no more than 5 mm. B. Under-running no more than halfway across the heel or sole. C. More extensive under-running of the heel or sole but not extending to the outside edge of the sole of the claw.

NSW DPI

Score 4



The under-running extends to the outside edge of the sole of the claw and involves hard horn.

NSW DPI

Score 5



This is a severe form of the disease involving the sole, with extensive inflammation and under-running of the hard horn of the hoof.

NSW DPI

Other conditions

A number of conditions can easily be confused with footrot, especially when they occur under the same environmental conditions. Some of these are outlined below:

Foot ('heel') abscess

Foot abscess is caused by *Fusobacterium necrophorum* (a bacterium that is ever present in the soil).

Foot abscess may be present in several sheep in a flock at the same time but is not contagious (usually only a small percentage of the flock is affected). It is usually seen in heavy sheep (pregnant ewes, rams), under wet paddock conditions, and is more common in the front feet.

Foot abscess develops from damage to the interdigital skin. This damage can be seen in the very early stages as a small 'nick' in the skin penetrating into the soft tissue in the interdigital cleft next to the heel.

Foot abscess usually occurs in one digit and usually only affects one foot.

Local heat, swelling and pain on palpation are usually observed. White or creamy pus may break out of the abscess at the coronet. The sheep may hold the affected foot off the ground.

There is no characteristic footrot odour and usually no separation of the sole, except at the point where the abscess breaks open.



Foot abscess: Infection is breaking out above the coronet (hoof line) showing hair loss and swelling. **INSET:** Swollen foot with infection breaking out between the toes.

Toe abscess

Toe abscess is the most difficult condition to differentiate from footrot. Toe abscess most commonly involves the front feet and results from damage to the hoof wall in the toe area. It occurs most often when conditions are wet and feet are overgrown. It can also occur as a result of shelly hoof.

Contamination enters through a crack in the hard horn, bacteria multiply and form an abscess, but the pus cannot escape through the hard horn, so it forms a track up to the coronet or back under the sole of the foot.

Toe abscess can be hard to differentiate from footrot without laboratory tests. It can appear as a red 'cherry' or proud flesh at the point of the toe after paring back under-run hard horn (although proud flesh can also be associated with overzealous foot paring).



Ovine interdigital dermatitis

Ovine interdigital dermatitis (OID) is an inflammation of interdigital skin, usually of more than one foot, during warm weather, particularly when the pasture is lush or muddy. This condition is also caused by *Fusobacterium necrophorum* (the causal bacteria for foot abscess).

As this bacterium is always present in the soil, OID can occur whenever weather and paddock conditions are favourable.

The symptoms of OID are similar to Score 1 footrot, with no under-running. OID can be differentiated from footrot by taking smears on glass slides or swabs for laboratory tests.

OID heals quickly if feet are kept dry, such as overnight on the grating in the shearing shed, or with footbathing.



Ovine interdigital dermatitis: Laboratory tests using smear samples are the only way to get a definitive diagnosis for OID.

Shelly toe

Shelly toe occurs when there is a natural dry separation of the outside of the hoof horn near the point of the toe. A cavity forms between the horn and the hoof and this often fills with soil and dung. The cavity is curved and symmetrical, and the wall on the hoof side of the cavity is relatively smooth. Usually both front, and sometimes both back, feet are affected.

This condition mostly affects Merino sheep, and occasionally other breeds, on improved pasture.

When paddock conditions are wet, and gravel packs into the cavity, the small stones can break through into soft tissue and allow bacteria to enter and cause toe abscess (see previous page for clinical signs of toe abscess).

If infection is not present, paring of the outer wall over the shelly area and cleaning the dung and soil out of the cavity is all the treatment required.



Shelly toe: Note elliptical shape of separation and relatively smooth, dry surface exposed by paring.

Orf (scabby mouth) infection of the feet

Orf (often referred to as scabby mouth) can occur as scabs on the feet above the coronet. There is no involvement of hard or soft horn of the hoof. Some sheep in the mob will usually show classical scabby mouth lesions.

Orf is often seen in unvaccinated young sheep grazing lush pasture, rough pasture or stubble. Orf usually self-cures in about three weeks — no treatment is required.



Orf: Cool, non-woolled areas such as the mouth, legs, feet, teats and poll are the usual sites of orf infection.

Strawberry footrot (proliferative dermatitis)

Strawberry footrot is caused by *Dermatophilus congolensis*, the same bacterium that causes lumpy wool.

Scabs appear on the legs from the coronet to the knee or hock with hair loss. Scab removal reveals a bleeding fleshy mass. There is no lameness unless the lesions are thick and then break, splitting the skin as well, or if lesions occur in the interdigital space. All ages and breeds are susceptible but lambs, weaners and hoggets are most commonly affected.

Treat affected sheep with long-acting oxytetracycline (antibiotic) and ensure sheep are kept dry until lesion are healed and shear off the scabs.



Strawberry footrot: All classes of stock can be affected by strawberry footrot and infection is usually above the foot, up to the knee.

Is it virulent footrot?

There is a continuous spectrum of strains of *D. nodosus* (benign to virulent) with different abilities to cause disease in a sheep's foot. There may be two or more strains of bacteria present on a property or within a sheep's foot. Different strains of footrot bacteria can be classified according to their 'virulence'. Virulence is a measure of the bacteria's ability to digest the connective tissue below the horn of the hoof, which leads to under-running.

Highly-virulent strains of the bacteria can rapidly under-run the hoof horn, leading to hoof separation, severe lameness and associated production losses. Low-virulence bacteria (referred to as benign) are less able to do this and infection with these strains is usually confined to the skin between the toes, with occasional mild under-running of the soft horn only. There are also intermediate strains that fit between benign and virulent.

Due to the influence of host and environment, severity of disease may not be an accurate indicator of the virulence of the strains present in the hoof. Laboratory testing has its limitations as well - negative test results should not be interpreted to mean that virulent strains are not present, but merely that they have not been detected by the test. The least risky option is to only introduce animals onto your property from flocks that have no history of footrot - benign or virulent.

If virulent disease is present it is fair to assume that there will be a virulent strain of *D. nodosus* present. However if there is only benign disease present then either benign or virulent strains could be present.

Laboratory tests can assist in determining the virulence status of the footrot infection (see **Section 3. Laboratory diagnosis**). In New South Wales, laboratory testing is conducted at the discretion of a District Veterinarian, and is used as an aid to diagnosis in conjunction with a field examination of a sufficient number of sheep.

In some cases, laboratory testing will not be conducted because the diagnosis is definitive at the time of flock examination/ inspection.

Guidelines for clinical diagnosis of virulence

Any lesion detected in the hoof of a sheep should give rise to the suspicion of footrot, unless it can confidently be diagnosed as one of the other causes of lameness. Further investigation is warranted.

Foot note

Take samples for laboratory diagnosis when any suspicious lesions (even score 1 and 2) are seen.

Footrot diagnosis

Key messages

- Footrot is diagnosed in the field. Laboratory testing is used as an aid to diagnosis.
- A range of tests can be used to determine whether footrot is present and the level of virulence of the given strain.
- An additional test can be used to identify the particular serogroups of bacteria present.

Footrot is clinically diagnosed by evaluating characteristic foot lesions in the field and culturing the footrot bacteria (*Dichelobacter nodosus*) in a laboratory if deemed necessary.

A prompt, accurate diagnosis helps to determine the best treatment program to reduce the impacts of the disease. The course of action needed will differ depending on whether benign, intermediate or virulent footrot is present.

Laboratory tests can determine both the presence and virulence of the footrot bacteria and the 'serogroup'.

There are 10 different serogroups (groups of bacteria containing a common antigen) of footrot bacterium. Immunity to footrot is serogroup-specific, so if sheep are vaccinated with one serogroup-specific vaccine they can still be infected by other serogroups.

Knowing which serogroups exist within a flock is important when considering the use of serogroup-specific vaccines as a control treatment. See [Section 6. Specific vaccines](#) for more information.

Inspecting flocks for footrot

In New South Wales, footrot is a field based, clinical diagnosis. A sufficient number of sheep from the high risk mobs must be individually tipped, examined and lesions scored. Assessing the lesions observed against the current environmental conditions is an important aspect of this inspection, and repeat examination after conditions favourable for spread of footrot may be required to make a definitive diagnosis. Presence of any under-run should give rise to the suspicion of virulent footrot, which can be further confirmed by laboratory diagnosis.

Where lesions of Score 4 or greater are detected in more than 1% of any mob, a field diagnosis of virulent footrot is made.

The testing process

1. Taking the sample

Local Land Services district veterinarians, biosecurity officers and private vets have the required equipment to collect samples for footrot diagnosis.

It is important that samples are collected from a range of lesions from the most recently infected sheep.

2. Determining presence or absence of the *D. nodosus* bacteria

Culture

To grow a bacterial culture, sample material is smeared onto agar plates containing ground up ovine hoof material, then incubated in conditions that allow the bacteria to grow and multiply. The *D. nodosus* bacteria grow best at temperatures between 37–39°C in conditions where no oxygen is present.

The agar plates are examined after four days to see if bacterial colonies typical of *D. nodosus* have grown. If so, these colonies are transferred to another growth plate and incubated for a further four days. These colonies can then be tested (see Step 3) to determine the virulence and serogroup of the strain.

3. Determining virulence of the bacteria

Elastase test

In New South Wales, the elastase test is the primary laboratory test for determining the virulence of a footrot-infected flock. Elastase test results are considered in combination with the lesions observed at inspection and current environmental conditions when determining the virulence of the infection.

Elastase is an enzyme produced by some isolates of *D. nodosus*. It enables the bacteria to break down elastin, a component of the tissue connecting the hoof horn to the rest of the foot.

In this test the speed at which the bacterium breaks down elastin indicates its virulence. Test plates are checked every four days for up to 20 days to determine the results.



Virulent strains of *D. nodosus* bacteria take 4–12 days, benign isolates take 16 days or greater to break down the elastin and clear the plates.

Therefore, the time taken to receive results will depend on the type of laboratory test undertaken.

In the past, various methods of testing have been used, including the IntA PCR test and Protease test (also known as gelatin gel test). Nowadays the main test used in NSW is the Elastase test.

4. Determining which ‘serogroups’ of bacteria are present

Polymerase chain reaction

Polymerase chain reaction (PCR) is a technique used to copy a single piece of DNA from the footrot bacteria many times.

This DNA material can then undergo a process known as electrophoresis to produce a distinct pattern for each different serogroup of *D. nodosus* present. This enables each individual serogroup of footrot present in a particular sample to be identified by a letter of the alphabet (from A to I, plus M). The serogroup does not determine virulence of the *D. nodosus* strain present.

For example, a virulent serogroup A and a benign serogroup A can be isolated from the same flock.

Slide agglutination test

The slide agglutination test is a rapid screening test in which serogroup-specific anti-serum produced from a rabbit is mixed on a glass slide with some of the *D. nodosus* colony grown on the agar plate, and observed for a reaction (seen as flecks in the mixture if the colony is the same serogroup as the rabbit anti-serum).

The *D. nodosus* colony is tested against anti-serum to each of the different serogroups of footrot bacteria to determine the serogroup.

Taking a sample

Key messages

- Footrot can be clinically diagnosed by evaluating characteristic foot lesions in the field and culturing the footrot bacteria (*Dichelobacter nodosus*) in a laboratory. A veterinarian is required to diagnose virulent footrot.
- Sampling during periods that favour the expression of footrot ensures a more accurate assessment of the true nature and extent of the disease.
- Prioritise mobs, individual sheep and affected feet according to the aims of the footrot eradication program.
- Samples can be placed in transport media for transport to the laboratory; ideally within 24 hours of sampling.

Footrot can be clinically diagnosed by evaluating characteristic foot lesions in the field and culturing the footrot bacteria in a laboratory.

A prompt, accurate diagnosis helps to determine the best treatment program and reduces the impacts of the disease.



Regular monitoring: Signs of footrot are often more obvious during warm, wet weather (spread period). Lameness is usually the first indication of infection.

The course of action needed will differ depending on the percentage infected and severity of footrot present and your local District Veterinarian will be required for diagnosis.

When to sample

It is recommended to sample sheep for footrot when the disease is spreading (the spread period) and a full range of active lesions are present — usually when conditions are moist and warm. A flock infected with benign or intermediate strains of footrot may show few signs of footrot most of the year but the disease may reappear during a spell of warm, wet weather.



Field sample: Samples taken in the field can be sent for laboratory analysis to determine the strain and virulence of footrot.

A flock infected with a virulent strain of footrot can also show few signs of infection until warm, moist conditions trigger the onset of sudden severe lameness in large numbers of sheep.

It is difficult to sample sheep with deep-seated pockets of infection, and you are more likely to miss some less virulent, but still significant, strains by sampling during a 'non-spread period'.

Sampling during periods that favour the expression of the disease ensures a more accurate assessment of the true nature and extent of the disease.

Selecting suitable sheep

Mob selection – prioritise the mobs most likely to be affected by footrot. This could include:

- mobs with the greatest proportion of lame sheep and mobs with the greatest severity of lameness
- mobs of older ewes and rams



Sheep selection: When choosing sheep from which to take samples, select those with clear signs of lameness.

Image courtesy: DPIRD

- mobs recently introduced to the property or those potentially exposed to strays or grazing adjacent to neighbouring flocks.

Sheep selection – sample sheep showing signs of lameness.

Foot note

The more 'active' (plenty of moist, creamy exudate) and clean (free from mud or manure) the lesion is, the higher the chance of a successful culture. Dry lesions or heavily contaminated swabs reduce isolation rates in the laboratory.

Foot selection – select a range of feet showing a variety of lesions from Score 2 to Score 5 (if present) if the aim is to detect all serogroups/virulent strains present. If the aim is to determine the virulence of the most virulent strain present, select the feet with the highest score.

If an individual sheep (for example a bought-in ram with a suspect foot) is presented for sampling, it may be worth wet bandaging for several days to encourage bacterial growth and increase the chances of culturing the footrot bacteria.

Do not take samples from fly-struck feet as the laboratory rarely isolates footrot bacteria from such samples.

Sample number



Foot selection: *The more 'active lesions', the higher the chance of a successful culture and meaningful test result.*

5 - 20 samples will be taken from a range of fresh lesions in order to gain a laboratory diagnosis. It may be necessary to return to take more samples if laboratory testing is not successful.

Lesion selection

Moist and active lesions are the most suitable for sampling. In early cases the moist exudate from the inflamed interdigital skin or whitish-cream dead tissue from the skin-horn junction is ideal.

In more advanced cases, collect the moist, white or grey exudate from the advancing edge of the under-run lesion. Avoid faecal and mud contamination of the swab as much as possible.

Preparation for sampling

When taking footrot samples, the aim is to keep the bacteria alive and remove competition from other contaminating bacteria. Footrot bacteria die in the presence of dry conditions, oxygen and sunlight so it is important to protect the swabs from air and light and to keep them moist.

Have high-risk mobs (for example rams, older ewes, recent introductions, strays, mobs from the boundary paddocks) affected with footrot held in grassy paddocks close to the yards ready for sampling. Run sheep into the yards just before sampling to reduce mud and faecal contamination. Shedding sheep overnight before sampling can make sampling of Score 2 lesions difficult.

Foot-swabbing technique

Make sure all the necessary equipment and supplies are on hand — swabs, transport media and slides can all be sourced from your local animal health laboratory.

1. Select a lame sheep, preferably Score 2 to 5.
2. Remove mud and other material from the sole and interdigital cleft. Locate suitable lesions for sampling.
3. Collect samples from interdigital skin (skin between the toes) rather than under-run areas if clean exudate is present.



Sampling equipment: Ensure sampling equipment is close to hand when taking samples. Transport media, cotton swabs and glass slides can be sourced from your laboratory.



Hoof preparation: Carefully pare the hoof to remove overlying horn and any contamination to reveal a clean area of under-run infection.

4. Pare the hoof carefully using sharp footrot shears to remove overlying horn contaminated with faeces and soil, but avoid paring away all the under-run hoof – leave a clean area of under-run hoof over an area of active infection.
5. If the under-run area does not lend itself to uncontaminated swabbing, and there are plenty of sheep to choose from, record the foot score, raddle the sheep and let it go.

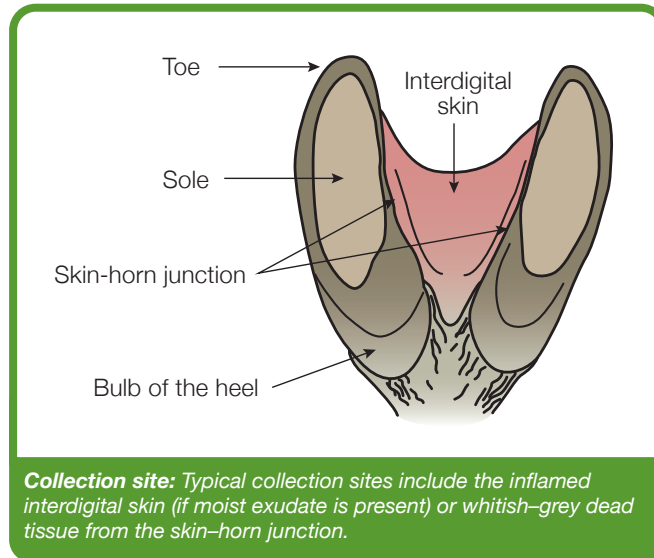

Collection site: Typical collection sites include the inflamed interdigital skin (if moist exudate is present) or whitish-grey dead tissue from the skin-horn junction.

Foot note

When taking samples, clean the blades of footrot shears between each sheep with a clean section of paper towel – don't use disinfectant as it may render the next sample you collect unusable.

6. If the foot is suitable for sampling, proceed to take a swab. Use high-quality swabs packed individually. The cotton tip of cheap swabs will unravel and make it hard for the laboratory to get a useful culture.
7. Collect material by gently pushing the cotton tip of the swab into a clean, actively-infected area. Roll the cotton tip and rub it over the affected area for about 30 seconds to ensure plenty of exudate soaks into the cotton tip.
8. When obtaining a sample from an under-run lesion, pare the foot to remove most of the overlying horn, then cut a flap of horn over the most advanced edge of the lesion, lift the flap to allow access to the deepest, most active, least contaminated exudate and pass the swab under the flap to soak up as much of the least contaminated creamy footrot exudate as possible.



Sampling technique: Rub the swab in clean exudate in an active lesion, under a flap of sole, in a well-prepared hoof.

9. Only swab one foot on each sheep if possible to maximise the chances of finding all strains present in the mob. If few infected animals are present, sample more than one infected foot from a single sheep.

A smear can be prepared on a glass slide before placing the cotton swab in the transport media, by rolling the swab on a clean glass slide after rubbing it in the exudate. Label the slide with sheep tag number, mob and property, allow it to dry and place in a slide transporter for delivery to the laboratory.

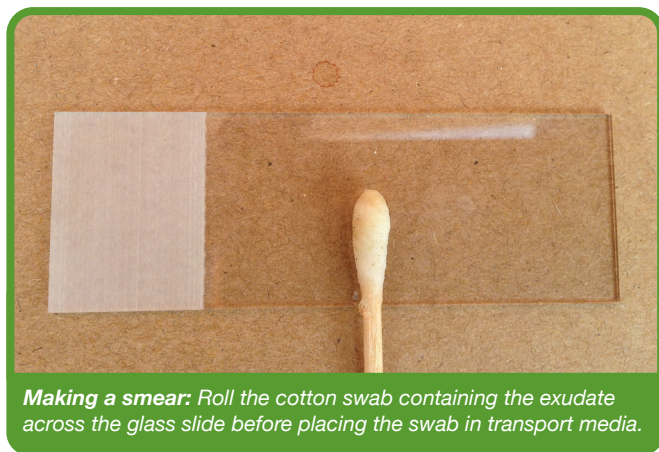

After preparing a slide, push the cotton tip deep into the transport media and break off the stick, screw on the lid, label, and store out of sunlight in an esky or similar container. Use one media bottle for each swab.

Stuart transport medium used for swabs is generally more liquid than that used for scrapings. Different laboratories vary slightly in their formulations of transport media, so contact your laboratory to determine the preferred specifications for sample transport.

The amount of material collected from a lesion is often small, so transport media may be modified to contain a higher concentration of agar



Suitable medium (left): Transport medium should be cloudy grey in colour.

Unsuitable medium (right): A strong blue colour indicates the medium has oxidised — do not use.



Storing the sample: Push the swab into the cloudy grey transport media and break off the stick.

in order to prevent dilution of the sample and to help maintain anaerobic (oxygen-free) conditions.

The colour of the transport medium should be cloudy grey. A strong blue colour indicates the medium has oxidised and is unsuitable for use.

Transporting samples

Contact your laboratory to determine their temperature requirements for samples during transport. Some laboratories prefer the samples to be kept at room temperature and stored in an esky with no ice bricks, and others prefer the samples be kept cool in an esky with ice bricks.

Ideally samples should be submitted to the laboratory and plated out within 24 hours of collection. Prompt processing of the samples at the laboratory after collection improves the chances of successful culture and isolation of the footrot bacteria. Contact the laboratory if delays of more than 48 hours between collection and plating out are likely.

If serogrouping is to be carried out, regional laboratories will send pure *D. nodosus* colonies to the University of Sydney for serogroup PCR testing. Stuart transport media is not suitable for transport of isolated colonies, these should be sent on hoof agar plates.

Eradication

Key messages

- The aim of any footrot eradication program is to reduce the prevalence of the disease to a level where all remaining infected sheep can be culled.
- Successful footrot eradication requires: planning, control, eradication and surveillance.
- Eradication involves controlling footrot during the spread period and immediately afterwards, by combinations of regular footbathing, foot paring, antibiotics, and possibly vaccination, followed by culling inspections during the dry, non-spread period.
- Careful consideration needs to be given before embarking on an eradication program — it can be a costly process, which requires sound on-farm biosecurity measures, skilled and thorough operators and vigilant monitoring and management.
- Footrot eradication can only be considered successful when all sheep have been through a spread period without any evidence of footrot.

Eradication program aims

In planning an eradication program, the LLS district veterinarian will consider the individual situation and decide how the outcome of eradication of footrot from the infected flock can be achieved with the least negative impact on the infected farm.

The aim of an eradication program is to get the prevalence of footrot low enough to be able to remove all remaining infected sheep from the property.

Treatments to control the spread of footrot may be applied during the spread period to reduce the number of infected sheep.

Most eradication programs involve controlling footrot through the spread period and immediately afterwards, by combinations of regular footbathing, foot paring, antibiotics, and possibly vaccination, followed by inspections during the dry, non-spread period.

It is difficult to undertake an effective eradication program during spring as the disease is still spreading from sheep to sheep and ewes may be lambing — it is better to wait until the end of the spread period to start culling inspections.

An eradication program planned in conjunction with, and closely supervised by, an experienced LLS district veterinarian, biosecurity officer or trained footrot contractor has the best chance of success.

While eradication programs can vary from farm to farm, depending on farm management practices, bacterial strains and virulence, they all have four basic stages: planning, control, eradication and surveillance.



Risk assessment: It is critical to evaluate the risk of reinfection from stock movements before embarking on a footrot eradication program.

NOTE: The presence of deer or cattle on the property should not deter an eradication attempt.

Planning

A practical and detailed eradication program needs to be developed, in consultation with a Local Land Services district veterinarian and may involve a local trained footrot contractor. This program needs to consider:

a. The risk of re-infection:

1. Can all boundaries be secured so infected stray sheep or goats are unable to access the property?
2. Can all sheep and goats on the property be mustered (or otherwise eliminated)?
3. Can any introduced sheep and goats be kept isolated from the flock until they are confirmed to be free of footrot?
4. Can sheep and goats be transported and returned to the property without reasonable risk of contracting footrot during their absence?
5. Do sheep have to walk between separate properties, across other sheep properties or on public stock routes or roads, etc.?
6. Are store lambs brought in from other properties each year?
7. Are sheep or goats agisted on or off the property frequently?
8. Can sheep be separated from cattle during and after the program?

b. Property management practices, flock structure and facilities.

- 1. Fences:** Internal fences need to be secure enough to guarantee all sheep are mustered for inspections.

Not every fence on the property has to be sheep-proof, but enough secure paddocks with adequate feed must be available.



Handling equipment: Effective sheep handling equipment will relieve the physical burden of inspections and increase the efficiency of the process.

- 2. One-year plan:** Infected flocks should complete their approved footrot eradication plan within two years of commencement.

If the property is divided by a road or the different mobs of sheep are kept on separate properties it may be possible to concentrate on eradicating footrot from a portion of the flock in the first year. However, for this to be feasible, absolute separation of the mobs needs to be possible, including separate yards, shearing and dipping facilities for each mob.

- 3. Handling facilities:** Fatigue is an important factor when inspecting and culling sheep as operators aim to detect every small pocket of infection.

Effective sheep handling equipment is a worthwhile investment. It is worth ensuring the lead-up race is well designed and positioned so sheep flow well into the handling equipment. If significant numbers of sheep are involved, handling them over the shearing board is impractical.

Lighting is critical. Working outside will provide sufficient light, but a roof or shelter may be required to prevent sunburn and for wet weather. If working inside the shearing shed invest in plenty of high-quality fluorescent lighting to minimise shadows.

Laneway systems that prevent infected and clean sheep crossing paths can be important during the spread period, if it rains during an eradication inspection period, and after eradication when handling introduced sheep. If it is a dry, non-spread period during an eradication inspection period it does not matter if mobs cross paths as long as sheep don't linger on ground affected sheep have crossed.

- 4. Skilled personnel:** Eradication can only be achieved by repeated inspections of all feet on all sheep. Farm staff or contractors can undertake these inspections, but there must be a genuine commitment to finding every infected sheep — this includes clean mustering as well as rigorous foot inspecting.

At least three inspections are required before the spread period. As the non-spread (dry) period can be relatively short (2–4 months), inspections need to start soon after the end of the spread period and be scheduled to continue through the non-spread period.

Foot note

Any person undertaking an inspection needs to be well trained, methodical and have the time and patience to do the job properly so ALL infected sheep are identified. An effective principle is to have the person with the most to lose carrying out the final inspection on each sheep.

If using farm staff for culling inspections, consider working for the morning on footrot and then carry out other work in the afternoon.



Skilled operators: *It is essential all staff or contractors are well trained, methodical and committed to finding every infected sheep during the inspection process.*

Inspection must be at least 3 weeks apart to allow lesions time to heal. On some large properties it is simply not possible to inspect all sheep three times during an average summer with existing staff and/or facilities, however these inspections need to be considered a priority. Other farm work needs to revolve around the footrot program. If labour resources are limited, consider employing skilled and reliable contractors. Without a commitment to inspections, an eradication program is unlikely to succeed.

5. Financial considerations: An eradication program can be expensive and time consuming and may not be successful in the first year. Half measures are unlikely to result in success. Fences and other facilities may need to be upgraded, sheep handling equipment purchased, additional labour or contractors employed, and culled sheep will probably be sold at a discount.

Young sheep may need to be retained to replace culls and store sales may be reduced. Time and financial costs need to be fully assessed before committing to an eradication program.

Have a contingency plan in place in case the disease reappears in one or two mobs following the eradication phase — separate areas (with separate handling facilities if possible) need to be available so clean and infected mobs can be kept separate if this situation arises. This can incur more expense.

Control

Effective control measures employed during the spring spread period aim to reduce the number of chronically-infected sheep to a level that allows them all to be culled during the eradication phase. This can be difficult in spring-lambing systems, where ewes and lambs cannot be disturbed during lambing and after marking.

If too many sheep are still infected as the non-spread period starts, it may be possible to use antibiotics or a vaccine with a high cure rate at this time. Sometimes it is necessary to wait a few years for a dry spring with little spread and then take advantage of the low infection rates going into summer.



Effective control: Control during the spread phase can be achieved by footbathing, foot paring followed by footbathing or vaccination, or a combination of controls.

If effective control is achieved during the spread period there will be far fewer sheep with severe lesions during summer inspections, so the decision to cull is straight forward. Without effective control the number of sheep with severe lesions during summer may be too great to cull them all.

Control during the spread phase can be achieved by foot paring/footbathing or vaccination, or a combination of both (see [Section 6. Footrot vaccine](#), and [Section 8. Treatments](#)).

Footbathing and vaccination

Footbathing can reduce the severity of infection and the number of sheep infected during the spread period and helps heal affected feet, but when used in isolation it won't eradicate footrot.

Foot note

Footbathing and vaccination used in combination are effective in controlling the spread of footrot during the spread period; often reducing the incidence of infection within the flock to less than 5–10%.

Antibiotics

Sometimes, control strategies may not have reduced the incidence of disease after the spread period to a level (usually below 5–10%) where culling all remaining infected sheep is practical. Antibiotics can be used to try to reduce the numbers needing to be culled or to try to salvage particularly valuable sheep.

There are risks associated with adopting this option as antibiotics will not cure all sheep affected with footrot. The longer these non-responders remain on the property during the eradication program, the greater the risk of them infecting clean sheep. Consult a veterinarian before deciding to use antibiotics during an eradication program.

Cull any sheep that do not respond to antibiotic treatment after the first inspection as soon as the withholding period has expired — DO NOT treat any sheep for salvage at subsequent inspections. Antibiotics are only available through a veterinarian and correct dosing is important. Sheep need to be kept on grating for 24–36 hours after treatment to ensure feet remain dry immediately after treatment. After this period, run treated stock in dry paddocks for a month until the first culling inspection.

Long-acting oxytetracycline antibiotics are considered the most effective for treating footrot. Always observe withholding periods before sending non-responder sheep to slaughter.

Footrot is eradicated by culling, rather than treating infected sheep. Programs are likely to fail if too much time is spent trying to cure infected sheep rather than focusing on detecting and culling any carriers.

Control treatments, such as footbathing and antibiotics, applied during the eradication phase of the program increase the difficulty of detecting sheep still not completely free of infection and hence increase the risk of eradication program break down. More importantly these procedures take time and distract from the most important task – culling infected sheep.

Inspect and cull

When effective control of footrot is achieved, thoroughly inspect all the feet of all the sheep in the flock after the spread period has finished (usually during the dry conditions of summer). Don't run sheep on irrigated paddocks during this period.

A decision needs to be made whether to:

- a. de-stock mobs with too many infected sheep,
- b. cull individual infected sheep, or
- c. treat infected sheep (only consider this option when too many sheep are still infected at first inspection and culling them all is not an option. Give them one go early in summer, consider antibiotics).

The aim of the eradication phase is to identify and remove all the remaining infected sheep from the flock when footrot is not spreading, so they cannot re-infect clean sheep during the next spread period.



Thorough inspection: Following effective control it is important to inspect again every foot on every sheep in the flock after the spread period has finished.

Foot note

If a treatment mob is retained after the first inspection they must be marked with a long lasting marker and run separate to the sheep inspected clean. Any sheep still showing signs of footrot after the first treatment should not be retained.

Turn over and individually examine every sheep at each inspection, paring sufficiently to make an accurate diagnosis. The first inspection will be slow as feet will often be long and deformed. Subsequent inspections will be faster as minimal footparing should be required. When foot paring, take care to avoid causing any bleeding, be methodical, and don't try to break any time records.

All feet of all sheep need to be re-inspected 3 or more weeks later and all infected sheep culled. There should be no further treatment for sheep treated at the first inspection.

Generally less than 1% of sheep will be detected with footrot at subsequent inspections. Identify infected sheep with a distinctive colour mark or branding fluid on their head. Use a different colour on clean sheep – this helps assess how effective mustering and fences are.

Foot note

When inspecting feet, the golden rule is 'if in doubt, throw it out'. Don't look at the wool, the mouth or the pedigree; if it has a suspicious foot, cull it. Get all infected sheep off the property as soon as possible to reduce the risk of accidental mixing.

After all infected and suspect sheep have been culled, carry out a further two clean inspections — where no footrot is found — before spread conditions return (see *Section 7. Eradication inspections*).

Surveillance and prevention

Footrot eradication can only be considered successful when all sheep have been through a spread period without any evidence of footrot. Ongoing monitoring is essential after a mob has gone through the intensive control and eradication program to ensure footrot has been eradicated and to prevent reinfection.

Keep all mobs as separate as possible through the next spread period so if a breakdown occurs it is limited to a single mob. Don't mix sheep unnecessarily, don't cross paths without a seven-day spell between mobs.

Regularly observe all sheep and examine any lame sheep throughout the following spread period. Mark the sheep after examination. If footrot is found, take measures to ensure infection does not spread to other mobs. Run an eradication program on the infected mob next summer or cull the whole mob.

After the spread period organise for an LLS district veterinarian, biosecurity officer or trained footrot contractor to inspect all mobs again to ensure the eradication program has been successful. If any lesions of footrot are identified in any mobs at this inspection the eradication has been unsuccessful, and a new program will be required for the infected mobs.

Surveillance needs to be ongoing — especially in boundary paddocks and for introduced mobs.

Prevention involves employing a program for introduced sheep to ensure they don't bring footrot back onto the property and maintaining secure boundaries. Have an agreement with neighbours that they don't just drop your sheep back over the fence.

Footrot vaccine

Key messages

- The use of footrot vaccines is subject to approval by the NSW Chief Veterinary Officer. Your local District Veterinarian will seek such approvals as required.
- Footvax is a multivalent footrot vaccine that can be used to reduce the incidence and spread of virulent footrot and reduce disease prevalence.
- Producers using Footvax multivalent vaccine do not need to know which serogroups are present in their flock to use the vaccine. If used as a tool in preparing for a summer eradication programme, producers need to be vigilant in their approach to disease eradication and ongoing management.
- Ongoing flock monitoring and on-farm biosecurity are critical to keeping footrot out after eradication.

Footvax multivalent footrot vaccine

Footvax is a killed multi-serotype (10 strain, it does not contain M strain) vaccine registered to aid in the control of footrot in sheep. Effective vaccination can provide a protection rate of up to 80% of the flock and cure around 60% of infected sheep. Following two vaccinations at least 6 weeks apart, sheep are protected against footrot for up to 10-12 weeks in Merinos and up to 16 weeks in British breeds. Effective immunity is developed after the second dose. Further booster vaccinations if required, up to 12 months later, will again give a similar protection period.

Given that the protection provided by the vaccine is short term, timing of a vaccination program is critical, and the booster vaccination needs to be timed just before the expected start of the spread period, so sheep have high levels of immunity when they are most susceptible to getting footrot.

Depending on the area, a further booster may be required after 10-12 weeks if conditions are still suitable for footrot spread. If conditions are drying out, footbathing weekly until conditions are dry will be sufficient. If pastures are likely to be green for more than 4-6 weeks a further vaccination may be justified.

The inability of the vaccine to give total protection or cure all affected sheep means vaccination is only part of a well-planned footrot program. Vaccine use may be considered in situations where sheep cannot be footbathed regularly, such as with lambing ewes, extensive properties where mustering is difficult or any property where labour shortages or facilities preclude effective footbathing.

Please contact your local LLS district veterinarian if you wish to explore this treatment option.

Monitoring

When footrot appears to have been eradicated, monitor for a breakdown. Check any lame sheep as soon as they are detected. If footrot is found, isolate the affected mob and decide whether to inspect and cull again, or whether to take another set of swabs.

Continue to monitor for as long as footrot is assumed to have been eradicated.

Introducing new sheep

Ask the vendor to provide a Sheep Health Declaration with the footrot section completed.

Inspect all introduced sheep, including rams, on arrival, footbath and isolate for as long as possible (a minimum of 6–8 weeks) - even sheep that have been bought from properties with a 'footrot-free' reputation. Ideally, isolate these new sheep in a wet paddock where footrot is likely to show up before being mixed with other sheep.

Ongoing biosecurity

Maintain sheep-proof boundary fences as much as possible.

Ask neighbours to keep any of your strays and ensure you pick them up, rather than having a neighbour drop them back over the fence. Treat these as new introductions (see left).

If a neighbour's sheep stray onto the property, immediately isolate the mob, remove the strays, inspect their feet and take appropriate action based on the status of their feet and current conditions underfoot.

Foot note

There are some expenses producers must be prepared for, and results are not guaranteed. Post-vaccination inspections and culling of all infected sheep are critical and must be carried out thoroughly.

Eradication inspections

Key messages

- Eradication inspections are absolutely critical to the success of any footrot eradication program.
- Sheep handling equipment will reduce operator fatigue and increase handling efficiencies.
- Developing a well-thought-out program will ensure the inspection operation is carried out in a timely manner, reducing conflict with other farm jobs.
- A thorough inspection technique is critical to ensure every last foot is inspected, all sheep infected with virulent footrot are identified and appropriate measures are taken in a timely manner.

Eradication inspections are absolutely critical to the success of any footrot eradication program. Every last infected foot needs to be found and the affected sheep culled to achieve a footrot-free flock.

Weight the dice in your favour. Get well set up, establish some clear rules-of-thumb and proceed with confidence.

Efficient handling facilities

Unless sheep numbers are low, use effective and efficient sheep handling equipment or employ contractors.

Sheep handling equipment will reduce operator fatigue, footparing will be more accurate, there will be less blood, and any footrot lesions will be more visible. Sheep throughput will be increased with the right equipment, leaving time for other jobs.

While it is critical to have good lighting, and working outside in the yards provides plenty of light, operators also need to be protected from sun, rain, dust and wind. If working inside a shed, have plenty of cool fluorescent lights set up so shadows don't fall over the sheep's feet.



Ease of handling: Well-designed sheep handling equipment can ease the load of eradication inspections, reducing operator fatigue and increasing handling efficiencies.

A constant flow of sheep is important, as is a set-up where sheep move into the handler without too much coercion. Well designed, sound fences and yards will support efficient sheep flow. Skilled dogs and sufficient labour to keep sheep up to the person doing the foot inspections also is important.

Be prepared

The key to avoiding operator fatigue and ensuring a thorough inspection is to develop a well-oiled routine — don't try to break any foot inspection world records.

The first inspection usually takes longer than subsequent inspections as more paring tends to be carried out first time around. While the subsequent inspections often are faster, don't get carried away — still inspect every foot thoroughly.

Inspecting a mob in the morning, followed by less demanding tasks in the afternoon, can prevent fatigue from affecting results late in the day. Take breaks as required, keep up fluids and eat enough food to stay bright and alert.

Some experts claim the person with most to lose if eradication fails should make the final decision on each sheep. In any case, the people carrying out these inspections, and making the decisions, must be motivated and genuinely keen to see the disease eradicated.

Foot note

Do not have a hospital mob! Concentrate all your efforts on clean sheep. Treatment may be an option early in the non-spread period if the prevalence is too high to cull all infected sheep, but any infected/suspect sheep from then on must be culled. Mark culls, keep them in a secure paddock and send them to the abattoir (as long as they are fit to load and all withholding periods have expired) as soon as possible.

Infected/suspect sheep must be well-marked in case they escape from their paddock or get mixed up with another mob for some other reason. Identifying clean sheep helps identify clean musters. Poll dotting with branding fluid for both clean and infected/suspect sheep (using different colours) ensures sheep can be clearly identified. Use branding fluid rather than spray marker, as branding fluid lasts longer and doesn't fade as easily, but keep in mind some wool may be classed into 'brands' at shearing. Be aware of blue/green colour-blindness when selecting colours.

Carry out repeat inspections at 3 week intervals or greater to allow lesions to heal. Carry out at a minimum of three inspections, aiming for at least two clean inspections, before the non-spread period finishes.

Inspection technique

For second and subsequent inspections, it is not necessary to pare if the foot is clean and healthy and the wall and toe are not overgrown. Always twist the heels as some score 3 lesions can be present in a foot that looks fine on visual inspection alone, even after paring of the toe and wall.

It is difficult not to have some bleeding at the first paring/inspection when re-shaping deformed feet, but try not to draw



Thorough inspection: Always twist the heel when inspecting for footrot to reveal any hidden lesions.

blood at the subsequent inspections, as it will cover up lesions and make diagnosis more difficult as it is challenging to assess whether the lesion surface was originally moist.

Use consistent culling criteria and apply the precautionary principal – if in doubt, throw it out. Don't look at the wool, the teeth, the pedigree or anything else!

Old toe abscesses can be hard to differentiate from footrot – cull anything suspicious. Do not confuse shelly toe with chronic footrot lesions.

One vexing problem can appear if there is a little rain and some score 1 feet appear – some reddening is visible and maybe a small amount of exudate (fluid) and moisture on the inter-digital skin.

If there are too many sheep to cull, complete the required paring then mark all infected animals that will receive treatment with a long lasting, distinctive colour. Footbath this treatment mob for at least 10 minutes and re-inspect in three weeks. If the lesions are all healed when next inspected, the animals can remain on property, but any non-responders must be culled to limit them re-infecting remaining mobs.

Foot note

Always examine the feet in the same order and minimise distractions. If you stop to talk to someone, or do something else, start from the first foot again. Likewise, always pare the foot the same way, ensuring any defects are detected. Use the sole as a guide - if you keep parallel to, and level with, the sole, bleeding will be avoided. Some elongated toes have to be cut off to get started, but don't cut too close to the sensitive tissue.



Consistent approach: Pare each foot in the same way and ensure any defects or infection sites are detected.

Chronic 'carrier' lesions can be found under the heels, under the wall, in the toe area and under the flap of hard horn inside the front of the toe. Sometimes the lesion heals from the toe back down the foot and the lesion is in the heel area and even the back part of the wall. Use well-sharpened, hand-held footrot shears, pneumatic shears or electric pruners with straight paring blades. Some people use a sharp horse hoof knife as well.

Large, distorted 'club' toes can be hard to investigate properly and sometimes these sheep are best culled.

See [Section 2. Identifying footrot in the field](#) for descriptions and photos of a range of footrot lesions and other foot conditions, which can be mistaken for footrot.

Treatment

Key messages

- A number of treatment options are available to control and eradicate footrot — options vary in their efficacy, expense and time taken to employ.
- Culling is a critical part of any control and eradication program — cull all non-responders.
- Foot paring is an important part of both the diagnostic process and control program. Always take care to avoid excessive paring and unnecessary blood loss.
- Footbathing and drying on slatted floors for 12–24 hours after treatment, in combination with paring, is a commonly-used and potentially successful treatment option.
- A range of footbathing chemicals are available.
- Antibiotics are reserved for high value animals with virulent lesions. They are most effective when sheep are pared, footbathed, injected and kept on slatted floors for 12–24 hours after treatment.
- Footrot vaccines can be used to treat footrot – for more information read **Section 6. Specific vaccines.**

Curing and preventing footrot is an important part of both ongoing control and eradication programs.

Treatment options include: selective culling, paring, footbathing and antibiotics, as well as various combinations of these treatments.

Treatments vary in effectiveness, cost, and how long it takes to treat the sheep. Different treatments are suitable for different situations and managers need to know what treatments are the most appropriate at different stages in the management cycle.

Selective culling

In eradication programs all infected sheep must be culled over a non-transmission (non-spread) period. For ongoing control programs, culling of the worst-affected sheep is a good policy both for animal welfare and productivity reasons.

Many producers pare and inspect sheep during early (summer, immediately after the major spring spread period), and cull any sheep with Score 5 feet.

Susceptibility to footrot is hereditary and consistent culling is likely to reduce the prevalence over a period of years in closed flocks.

Paring

Full paring involves using well-sharpened, hand-held or pneumatic footrot shears or electric pruners with straight paring blades to cut away the under-run sections of the hoof. Footrot bacteria do not survive long when exposed to oxygen, and thorough paring will dramatically increase the number of sheep successfully treated.

Full paring is time-consuming, often painful for the sheep, and is best followed by footbathing. Many producers only fully pare Score 1 and 2 sheep and cull Score 3 and above.

Diagnostic paring is a limited cutting away of the hoof to show how far the under-running has progressed, and avoids excess bleeding.

Pneumatic shears or electric pruners with straight paring blades make paring feet quicker and easier and are particularly useful during summer when the hoof horn is very hard and excess hoof material needs to be removed.

Hand-held shears are useful for re-inspections during eradication programs.



Diagnostic foot paring: 1. Cutting off the long toe safely. 2. Taking off the overgrown lateral wall. 3. Sufficiently shaped, but under-run footrot apparent in bottom-most toe needs attention. 4. Paring back under-run toe, avoiding blood loss.



Foot paring continued: 5. removing remaining under-run hard horn. 6. foot paring completed, no bleeding, all under-run horn removed.

A common mistake is to pare too heavily, causing bleeding and lameness. Paring that leads to profuse bleeding impacts negatively on sheep welfare and will not improve cure rates.

Avoid bleeding when conducting diagnostic paring during eradication inspections, as blood obscures footrot lesions, making diagnosis difficult.

When reshaping deformed feet, use the sole as a guide — keep parallel to, and level with, the sole to avoid excessive bleeding.

Some elongated toes have to be cut off to get started, but don't cut too close to the sensitive tissue.

Footbathing

Footbathing is the most commonly-used option to control footrot. It is a cost-effective method of applying chemicals to the feet of a large number of sheep in a short time. Used properly, footbathing assists healing of footrot lesions and it prevents new cases for a period.

Footbath chemicals only kill on contact, and while most footbath solutions are effective at curing and preventing Score 1 and 2 (benign) footrot, they will not cure many sheep with extensive under-running (Score 4 and 5). Therefore, footbathing should take place after paring, as this is when it is most effective.

The response to footbathing depends on when and how it is used. If employed early in a spread period, and used regularly, footbathing usually results in a positive response.

Footbathing will help to reduce the number of sheep picking up new infections during the spread period by curing Score 1 and 2 lesions before under-running develops, and reducing disease transmission and risk of spread to other sheep in the mob. Keeping the number of infected sheep to a minimum will improve the chances of successful summer eradication.

Foot note

Footbathing alone will not eradicate virulent footrot from a mob or flock.

A well-designed footbathing program can help minimise the number of sheep needing to be culled at subsequent eradication inspections, but managers must be aware that lameness can be masked by footbathing and that repeated foot inspections are the only way to determine whether all infected sheep have been removed from a mob.

For properties with large numbers of sheep, footbathing is time-consuming unless a large footbath is built. Footbathing is not practical for ewes with lambs during the spring spread period, as it can increase the risk of mismothering. This limits the effectiveness of footbathing on most sheep breeding enterprises.

Footbathing chemicals

Zinc sulphate

Zinc sulphate is a popular footbath chemical. Zinc can be reused since it remains effective even in the presence of organic matter, such as plant debris, faeces and soil. Zinc sulphate is not a strong irritant, is safer and gentler on sheep, and does not cause hoof hardening.

It is important to note that zinc is a heavy metal, can be toxic if ingested, and does kill vegetation. Thirsty sheep that drink from the footbath may die of acute zinc poisoning.



Footbathing: Footbathing chemicals only kill on contact and will be most effective when preceded by foot-paring.

Zinc sulphate does not give off fumes and can be used inside or under a shed.

Zinc formulations

Some zinc sulphate products are registered for treating footrot. If using a registered product always follow the label directions.

Zinc sulphate heptahydrate is used as a 10% solution, which is 1kg zinc sulphate heptahydrate dissolved in 9 litres of water. 2% lauryl sulphate can be added for more effective penetration.. Leave sheep standing in the 10% solution for at least 10 minutes. Effectiveness can be improved by allowing the sheep to dry for 12-24 hours on a dry/slatted surface following the footbath.

Zinc will penetrate about 1mm into the soft horn of the sheep's feet under these circumstances, and this can cure some Score 1, 2 and early Score 3 feet. Where a treatment mob is established, repeating the zinc sulphate footbath daily for 5 days will decrease number of animals to be culled.

Zinc will 'strip' from such footbaths used in this manner, and a hydrometer can be used to maintain the zinc concentration above 10%.

Zinc concentration

Zinc does not evaporate, but the water in the mixture does. This means over time, an unused footbath not diluted by rainwater will become stronger. If the footbath dries right out, the zinc will crystallize in the bottom. In all cases, simply re-fill the footbath with water to the level it was at when the last footbathing session finished and check the concentration with a hydrometer.

To maintain adequate working strength the use of a hydrometer or concentration tester is recommended. The hydrometer measures the chemicals dissolved in the solution and will give a guide to strength. Fine solids in suspension may artificially raise the specific gravity but only by a small percentage. When taking a sample for testing, scoop it off the surface before the footbath is stirred up, or filter the sample before measuring the specific gravity.

It is best practice to measure the strength of the footbath solution with a hydrometer at least twice daily during long footbathing sessions. At a 10% solution the hydrometer should read 1050–1060 units.

If the concentration is too low add 2.5kg zinc sulphate per 100 litres of water to increase strength by 10 units.

If the concentration is too high add 25L water per 100L to decrease by 10 units.

Beer and wine testing hydrometers are suitable for use and are available from home brewing outlets. On many properties the use of a tester reduces the amount of zinc sulphate used by 50%.

Zinc disposal

Footbath solutions need to be changed when they become heavily contaminated.



Hydrometer: A hydrometer measures the levels of chemicals in the dissolved solution and can be used to manage the zinc concentration levels in the footbath.

Consider the disposal of footbath chemicals carefully. As zinc sulphate is a heavy metal and toxic to plants, take care to avoid contaminating pasture paddocks and water courses.

One way to dispose of footbath solutions safely is to pipe it into a properly constructed, covered, rubble-filled drainage pit near the footbath.

If waste zinc sulphate footbath is allowed to run down a surface drain or into a creek it will act as a herbicide, killing off the vegetation, leaving the area bare and dusty, and possibly causing erosion issues. Similarly, zinc run-off from sheep feet after they are released from the footbath will kill grass. Do not use sheep manure contaminated with zinc sulphate on gardens as it may act as a herbicide.

Zinc – method of footbathing

Stand sheep on a hard surface or grating prior to footbathing if possible to help remove as much dirt as possible. This will help minimise contamination of the footbath.

Effectiveness will be improved by foot paring to expose any pockets of infection prior to footbathing.

Stand sheep in the footbath for the time recommended by the manufacturer of the product or as above. Footbathing is only successful if all the sheep's feet remain in the footbath chemical for the recommended length of time. Standing on a dry surface for up to 24 hours after 10 minutes of footbathing can increase effectiveness.

Radicat

Radicat is a solution of copper salts used for footbathing. Any wool discolouration that may occur is claimed to be temporary and scours out naturally in 6–8 weeks. No withholding period is required.

Radicat claims protection against reinfection for up to two weeks.

Sheep are required to stand in the Radicat solution for at least 15 minutes then feet must be allowed to dry on grating for a minimum of one hour. Ideally, pare feet within four hours of footbathing.

Active ingredients do not strip out with use, separate, or settle on the bottom of the footbath.

Good cure rates can be expected but a number of footbathing sessions are required to achieve this.

Dispose of Radicat well away from a water course to avoid pollution and in a manner that meets all current regulations relating to chemical disposal.

Always wear personal protective equipment (PPE) when cleaning up a chemical spill.

As Radicat is corrosive, it is not recommended for use in metal footbaths. Radicat is best used in concrete, plastic or fibreglass footbaths.

Formalin

Formalin was once widely used as footbath treatment for footrot and is still registered for footbathing sheep. Always follow label directions. Excessive concentrations or frequent use can make the skin between the toes brittle and crack, resulting in foot abscess. **Formalin is not recommended due to the risk associated with its use.**



Take care: Always wear personal protective equipment such as gloves and rubber boots when handling footbathing chemicals.

Copper sulphate 10%

Copper sulphate has also been used in the past as a footbath solution, but the copper solution causes unscourable staining of the wool and hence is no longer widely used. It is corrosive so avoid use in metal footbaths. Effectiveness deteriorates significantly if the solution becomes contaminated with dirt and faeces. There are also concerns regarding copper contamination of the environment. Copper is toxic if too much is consumed by sheep or other animals.

Antibiotics

Antibiotic injections are only available on prescription from a veterinarian. Accurate dosing and sound hygiene procedures are important. Always discuss any proposed use of antibiotics with your veterinarian.

Only inject infected sheep with antibiotics. Antibiotics only protect against new infections for a few days. Best results are seen when sheep are pared, footbathed, injected and kept on slatted floors for 24–36 hours after treatment. Following treatment and holding, move sheep to a dry paddock and then inspect them 3–4 weeks later. Cull any non-responders following treatment. Cure rates for sheep treated in this manner can exceed 90%. Hence antibiotics are recommended for use early during the summer non-spread period for eradication programs where too many sheep are still infected at the start of the non-spread period.

Footrot vaccines can also be curative – for more information read [Section 6. Specific vaccines.](#)



Environmental hazard: Footbathing chemicals (such as zinc) can contaminate the soil surrounding the footbathing areas preventing regrowth of groundcover.

Foot note

It is important to observe any withholding periods before sending sheep to slaughter. Several antibiotics are registered for treating footrot, but the best results appear to be after the use of long-acting oxytetracycline antibiotics.

Footbath design and construction

Key messages

- A footbath is essential on sheep properties where the flock is infected with virulent footrot.
- Well-designed, constructed and located footbaths increase the ease and efficiency of the footbathing process and the success of any treatment program.
- If possible, locate the footbath where sheep will not have to walk over contaminated ground after leaving the bath and yards.
- When calculating the size of the footbath, consider how long the sheep need to be in the footbath, as well as the number of sheep requiring treatment.
- A permanent footbath is best built of concrete. Where only benign footrot is an issue, portable footbaths may be more cost-effective.
- In a large concrete bath allow one square metre per three woolly, or four shorn, sheep.
- Locate the footbath close to a water supply and near to easy, but safe, disposal of used footbath solution.

A footbath is essential on sheep properties where the flock is infected with virulent footrot.

Even on uninfected properties, a footbath can help prevent footrot being introduced when sheep are bought in from elsewhere, or as an aid to prevent foot abscess in rams and pregnant ewes.

Siting the footbath

Ideally, locate the footbath where sheep will not walk over contaminated ground after leaving the bath and yards. Sheep should stand in a dry area, for example on slatted floor or in a concreted yard, for up to one hour after footbathing if possible.

Locating the footbath at the exit from the shearing shed means that after sheep have moved through the shed most of the mud and dung has fallen off their feet, providing better contact with the footbath solution and less contamination of the footbath. When sheep learn they will be sent back to the paddock soon after footbathing, they enter the footbath more readily.

Locate the footbath close to a water supply and near to easy, but safe, disposal of used footbath solution. Consider the disposal of footbath chemicals carefully as some solutions can be toxic to livestock, aquatic life and vegetation. It is best to run spent footbath solution through a pipe to an underground pit filled with rubble, where the solution can soak away.

If only one or two mobs of sheep on the property are infected, or benign footrot (scald) is the only problem, portable footbaths may be a better option than a permanent footbath if sheep can stand on a dry area following footbathing.

Footbath design

When calculating the size of the footbath, consider how long the sheep need to be in the footbath, as well as the number of sheep requiring treatment.

Building a large footbath costs more up front, but is more cost effective in the long run for large numbers of sheep, due to the associated savings in labour costs.

In a large concrete bath allow one square metre per three woolly, or four shorn, sheep.

Foot note

Sheep do not like stepping into water. Loading the sheep into the footbath can take a lot of time if effective sheep handling principles are not used. Designs where the sheep walk up an incline and then into the bath can hasten the process, as they don't see the water until they are in the footbath.

Side-by-side wide race designs, or designs where the sheep that have just been bathed are held just the other side in a draining pen, and are clearly visible, will 'draw' sheep into the footbath.

Be conscious of reflections off the surface of the water at certain times of day. It is worth building solid walls to avoid reflections. Get down low enough to see what the sheep are seeing and try to make them think that going the way you want them to is a way of escape.



Clever design: Designs where sheep can be drawn into the footbath by the presence of other sheep held in a yard at the end of the footbath make footbathing easier.

Construction

A permanent footbath is best built of concrete. Obtain expert advice on cement content, the need for reinforcement mesh and general construction.

Baths may be constructed with either: a concrete floor and sides to a height of about 15–20cm, or a concrete floor and two layers of bricks for the sides. If using bricks, seal them with brushable sealant. Construct a yard around the bath using timber (most footbath solutions are corrosive to steel) with a gate at either end of the bath for sheep to enter and exit and a drain in the floor of the bath.



Portable solutions: For instances where it is not possible to construct a permanent footbath, galvanised metal footbaths can be used as an alternative. These can be placed end-to-end to increase the footbathing space per group of sheep.

It is important the yard panels around the sides of the footbath are solid from the top of the wall of the footbath to a total height of 300mm above the floor inside the bath, and meet the top of the wall of the footbath at the inside edge to stop sheep resting feet on a ledge.

A concrete pen with a gate at least 1.5m wide appears to work best. It will generally hold more sheep and the sheep run into it more readily than a race bath. Sheep are also less likely to go down in the bath. Stand-in rather than walk-through baths are preferable, particularly when using solutions that the sheep must stand in for some time, as this type of bath allows larger numbers of sheep to be footbathed at once and allows for the correct stand-in times.



Hidden solution: Permanent concrete footbath under slats in shearing shed. When the footbath is not in use, the grating sits back over the footbath allowing for normal use of the shed.

A roof over a footbath will reduce the chance of the solution being evaporated by the sun or diluted by rain. A bath under cover also may be easier to fill with sheep if it eliminates reflection on the water.

High-density foam, such as that used in foam mattresses, 10cm thick, placed in race-width footbaths will reduce splashing, save on footbath chemicals, stop sheep baulking at the water surface and stop sheep dogs drinking the solution. However, it can soon become damaged and pushed up one end of large baths. Foam lasts longer in race-type footbaths, and may be worth using while 'training' sheep to enter the footbath.

Cutting a section of weldmesh and laying it in portable metal or plastic baths will stop sheep slipping, but ensure there are no sharp edges that could cut the sheep's legs.

The depth of solution should be 5cm to 6cm (enough to cover the hoof). Solution soaking into the wool of the shanks is wasted.

Large, galvanized metal footbaths have been used with some success in areas where a permanent footbath cannot be constructed. Baths are generally 750mm wide to allow sheep to stand side by side and have high sides of up to 600mm to ensure all hooves remain in the solution and reduce chemical waste from splashing. Height at the entrance/exit of the footbath is kept to 250mm for sheep to be able to step over. Multiple baths can be assembled end to end along a convenient flat raceway, in a shed or yards. At the entry point into the baths it is ideal to restrict to a single sheep width (350-400mm) and include a ramp into the bath as this will assist with the flow of sheep.



Reuse and recycle: A footbath constructed from recycled intermediate bulk containers (IBC), with higher sides to reduce wastage and low entrance/exits to allow for easier loading.

Calculating the volume of the footbath

Multiply length x breadth x height in metres to give volume in cubic metres (and then multiply by 1,000 to give the capacity of the bath in litres).

1 cubic metre = 1,000 litres

Example

Length = 8m, breadth = 3m, height of chemical = 50mm (5cm or 0.05m)

Volume = $8 \times 3 \times 0.05$ cubic metres
= 1.2m^3 or 1,200L

Calculating the sheep-holding capacity of the footbath

Assuming that 3 x 60kg half-wool sheep occupy about 1m^2 of space, a footbath of $8\text{m} \times 3\text{m}$ (i.e. 24m^2) would hold about 72 sheep (i.e. 24×3).

See [Section 8. Treatments](#) for information on footbath chemicals and footbathing protocols.



Design considerations: Stand-in, rather than walk-through, baths are preferable, particularly when using solutions that the sheep must stand in for some time, as this type of bath allows larger numbers of sheep to be footbathed at once and allows for the correct stand-in times.

Figures 2a, 2b, 3, 4a and 4b on the following pages outline the key common features of a range of footbath constructions.

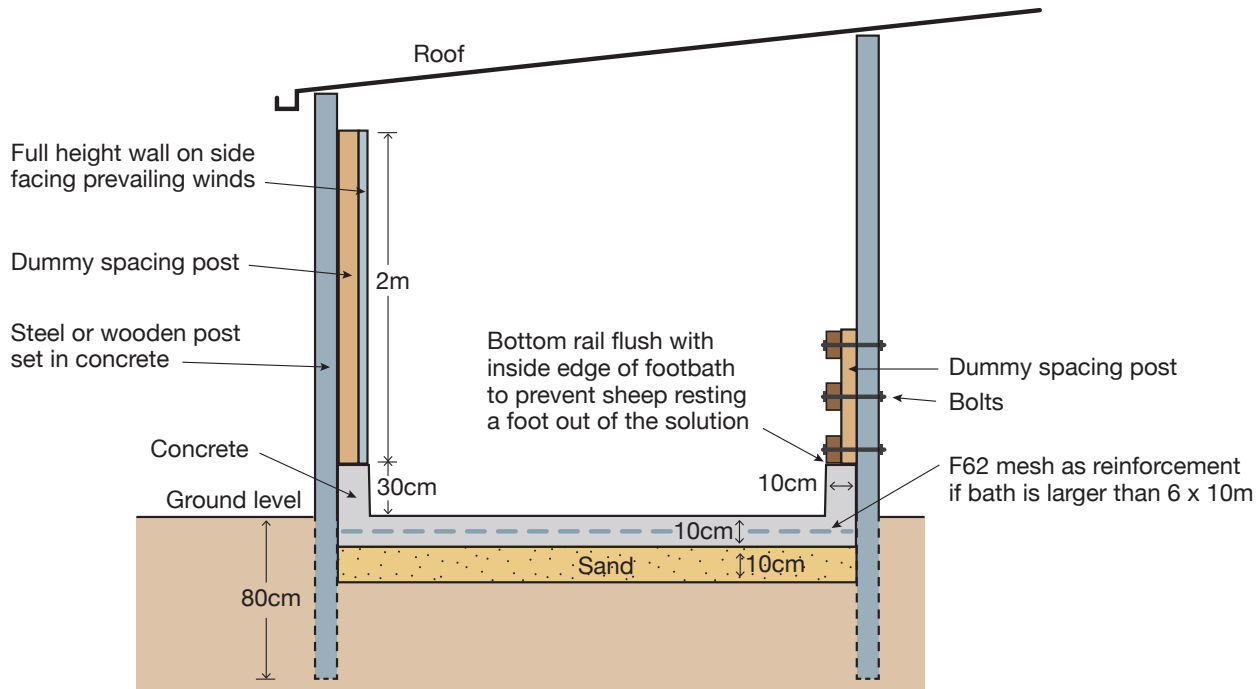

Figure 2a: Main features of a stand-in footbath — elevation (not to scale)

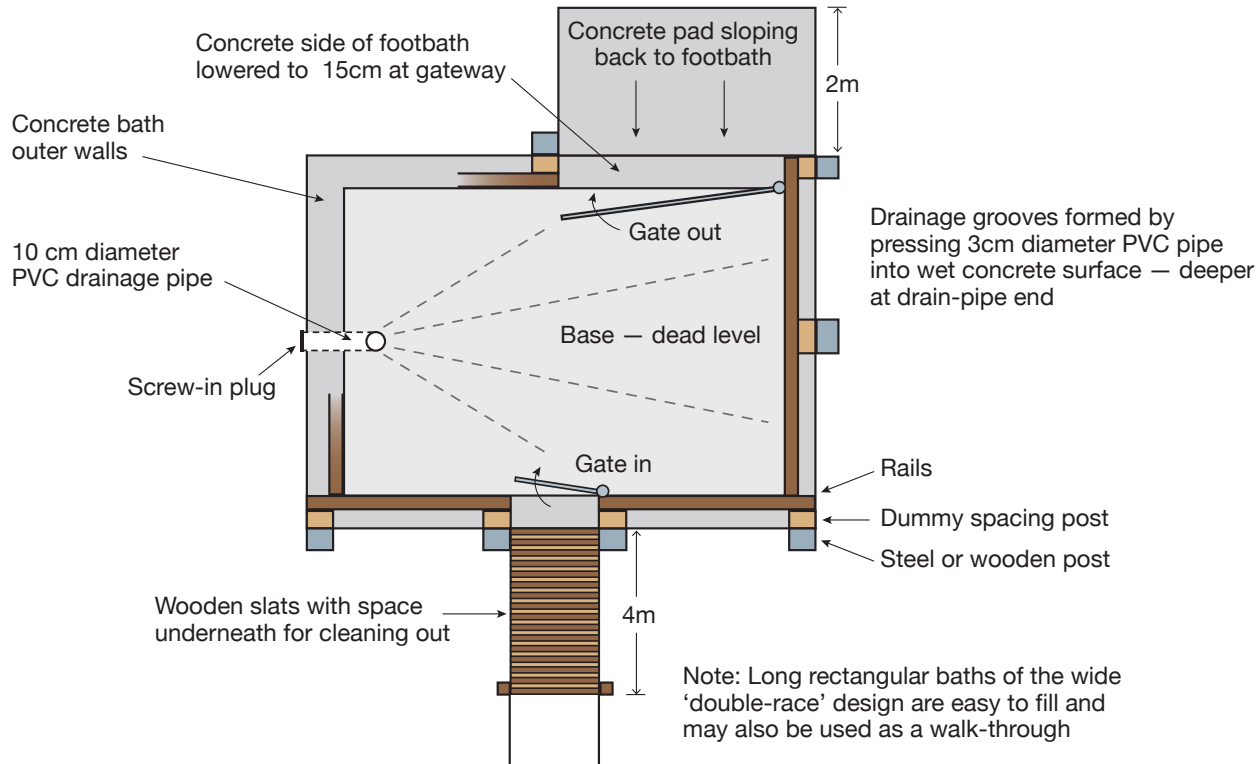

Figure 2b: Main features of a stand-in footbath — plan (not to scale)

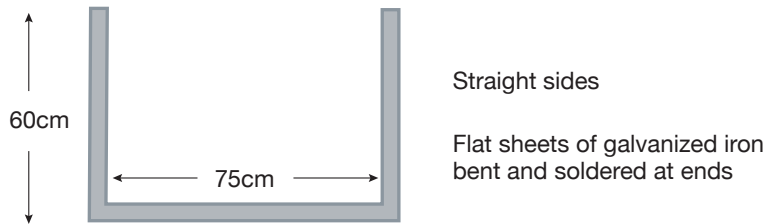

Figure 3: Main features of a portable footbath — cross-section (not to scale)

Top view

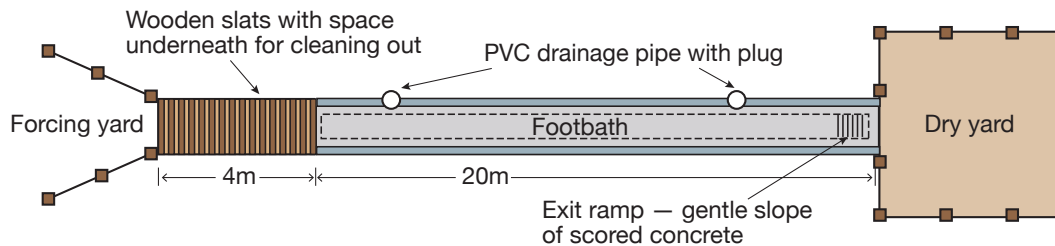

Figure 4a: Main features of a walk-through footbath — plan (not to scale)

Side view

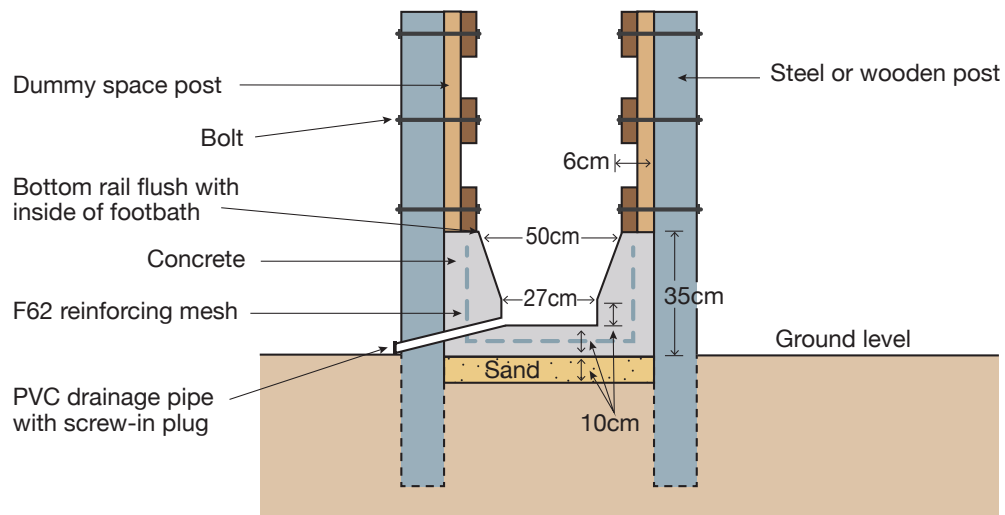

Figure 4b: Main features of a walk-through footbath — elevation (not to scale)

Surveillance and prevention

Key messages

- Regular flock monitoring and proactive management are the keys to preventing the introduction of footrot.
- Ensure fences are secure and regularly monitor and repair any damage.
- Work closely with neighbours to develop a footrot prevention program — avoid neighbours dropping strays back over the fence, ask them to let you know to come and pick up your stock so you can check them for signs of footrot and quarantine them from other sheep until they are footrot-free.
- Manage the introduction of new livestock (sheep, cattle and goats) carefully.
- Establish strict hygiene rules for visiting vehicles and foot traffic across paddocks.

If you have eradicated footrot, then you will want to prevent the disease becoming established on your property.

If you already have footrot and may want to use specific serogroup vaccines in the future, it is important to stop new serogroups of footrot from infecting your flock.



Under surveillance: Regular monitoring and prompt action will ensure footrot is not reintroduced following eradication.

Surveillance

The price of freedom is constant vigilance.

Regularly observe all sheep, especially in boundary paddocks and introduced mobs, especially during spread periods. Examine the feet of any lame sheep as soon as they are detected. Spray mark the sheep after examination to avoid examining again next time. If footrot is found, take measures to ensure infection does not spread to other mobs.

Also observe for 'strangers', isolate them and inspect their feet as soon as possible. Irrespective of the time of year, isolate the mob until you can diagnostically pare their feet. Actions will be determined by what you find in the strangers' feet and the time of year. If footrot is found and it is hot and dry, removal of the strangers may be all that is required. It is best to footbath and isolate the mob until a spread period has passed if possible.

Foot note

If active footrot is found in strangers during a spread period, isolate the mob and implement control measures until you can carry out an eradication program. Alternatively, cull the whole mob.

Fences and neighbours

Maintaining secure boundary fences is important, but trees can still fall over, gates can be left open, creeks can flood and fires can occur. Try to come to an agreement with your neighbours that they hold any of your sheep that stray onto their property and call you rather than drop your sheep back over the fence without your knowledge.



Boundary security: Ensure boundary fences are secure and repairs are carried out swiftly when damage occurs.

Introduced sheep

Treat all introduced sheep, including your returned strays, as suspect no matter where they come from — even rams from a trusted supplier of many years. Don't forget that puddy lambs, agisted sheep, goats and borrowed rams can all introduce footrot.

Ask the vendor to complete a National Sheep Health Declaration (SHD) including section B3 and B4 on footrot before you introduce the sheep.

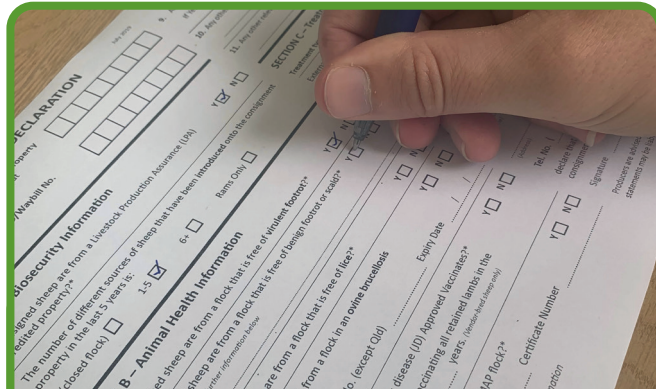

Due diligence: Always ask for a completed copy of the National Sheep Health Declaration from your vendor.

Foot note

Unload introduced sheep into the yards or shearing shed when they arrive, immediately inspect all feet of all sheep, diagnostically paring where necessary. Footbath the sheep before isolating them for as long as possible, ideally in an irrigated or wet paddock with long grass until a spread period has passed without any breakdown.

Feral goats

Feral goats often have little respect for fences and can be actively infected with footrot. Eradicate such feral pests as soon as possible.

Deer

Virulent footrot has been diagnosed in red deer in New Zealand, but surveys in Tasmania have failed to diagnose footrot of any virulence in fallow deer.

A number of properties in Tasmania have eradicated footrot and kept it out for many years in the presence of fallow deer. Fallow deer are not regarded as a high risk for spreading footrot.



Introduced cattle: Although the risk of introducing footrot with cattle is low, isolate any introduced cattle from sheep for 7–14 days during a spread period.

Introduced cattle

Cattle can be infected with benign footrot, but rarely carry intermediate or virulent strains. Their hooves can be contaminated with virulent footrot bacteria if recently co-grazed with sheep infected with virulent footrot. Although the risk is low, it is best to isolate introduced cattle away from all sheep for 7–14 days if introduced during a spread period.

Tyres and boots

Although the risk is low, it is ideal to have a rule that vehicles with potentially contaminated tyres do not drive over your paddocks during spread periods. Likewise, anyone who may have contaminated boots should change or clean and disinfect them before walking over your paddocks or yards during spread periods.

Conclusions

Footrot can be kept out of your property, but stringent hygiene practices, especially with introduced sheep, must be built into management routine and farm biosecurity management plans.



VISITORS

A Biosecurity Management Plan (the Plan) applies to this place. Failure to comply with the Plan may be an offence under the *NSW Biosecurity Act 2015*.

Please phone or visit the office before entering to obtain a copy of the Plan or to discuss your obligations.



DO NOT ENTER WITHOUT PRIOR APPROVAL
Vehicles, people and equipment may carry
weed seeds, pests and diseases

Biosecurity: Manage biosecurity with farm visitors by clearly setting expectations before they enter the farm.

Glossary

Benign footrot: Benign footrot (referred to as scald) usually only affects the skin between the toes regardless of the environmental conditions.

***Dichelobacter nodosus*:** The bacteria that causes all forms of footrot. There are many strains (or types) of *D. nodosus*, which vary in their ability to cause disease from benign to virulent.

Eradication: The elimination of all sheep and goats infected with virulent and intermediate strains of footrot from the property.

Foot abscess: Caused by *Fusobacterium necrophorum* (a bacterium that is ever present in the soil). Unlike footrot, foot abscess is not contagious (usually only a small percentage of the flock is affected) and usually only occurs in one digit, affecting one foot.

Non-spread period: Also referred to as non-transmission period. The non-spread period is when footrot does not spread from sheep to sheep — usually the hot, dry summer and early autumn months in southern Australia.

Orf: Orf (often referred to as scabby mouth) can occur as scabs on the feet above the coronet. There is no involvement of hard or

soft horn of the hoof. Orf usually self-cures in about three weeks — no treatment is required.

Ovine interdigital dermatitis (OID): An inflammation (reddening) of interdigital skin, usually of more than one foot, during warm weather, particularly when the pasture is lush or muddy. This condition is also caused by *Fusobacterium necrophorum* (the causal bacteria for foot abscess).

Serogroup: Footrot bacteria are grouped according to the antigen they contain — particular proteins in the fimbriae (small hairs) on the outside of the *D. nodosus* bacterium. The sheep's immune system produces antibodies in response to these proteins, which are quite specific — the antibodies to one serogroup will not protect against another serogroup. There are 10 main serogroups — A to I and also M.

Shelly toe (or shelly hoof): Occurs when there is a natural dry separation of the outside of the hoof horn near the point of the toe. A cavity forms between the horn and the hoof and this often fills with soil and dung. If infection is not present, paring of the outer wall over the shelly area and cleaning the dung and soil out of the cavity is all the treatment required.

Specific serogroup footrot vaccines: A specific vaccine is a custom-made vaccine that targets the serogroups of footrot present on any given property.

Spread period: Also referred to as transmission period. The spread period is a period when footrot spreads from sheep to sheep. Disease spread usually occurs when the average daily temperature is above 10 degrees Celsius, and soil conditions are warm and moist (usually in spring in southern Australia).

Strawberry footrot: Caused by *Dermatophilus congolensis*, the same bacterium that causes lumpy wool (scabs appear on the legs from the coronet to the knee or hock with hair loss). Removal of the scabs reveals a bleeding fleshy mass.

Toe abscess: Most commonly involves front feet and results from damage to the hoof wall in the toe area. It occurs most often when conditions are wet and feet are overgrown. Toe abscess can be differentiated from footrot by laboratory tests.

Transmission period: See *Spread period*

Under-running: Separation of the hard horn of the hoof from the sensitive soft tissue underneath, resulting in severe pain and lameness.

Virulent footrot: Virulent footrot often causes severe under-running (except in goats) and spreads rapidly in warm moist conditions.



Sheep Connect NSW: www.sheepconnectnsw.com.au



For further information:

Contact your Local Land Services District Veterinarian or Biosecurity Officer, local veterinarian or livestock consultant.

<https://www.lls.nsw.gov.au/help-and-advice/livestock-health-and-production>

LLS: 1300 795 299 DPI Biosecurity: 1800 680 244



Primary Industries